

# DIR<sup>®</sup>

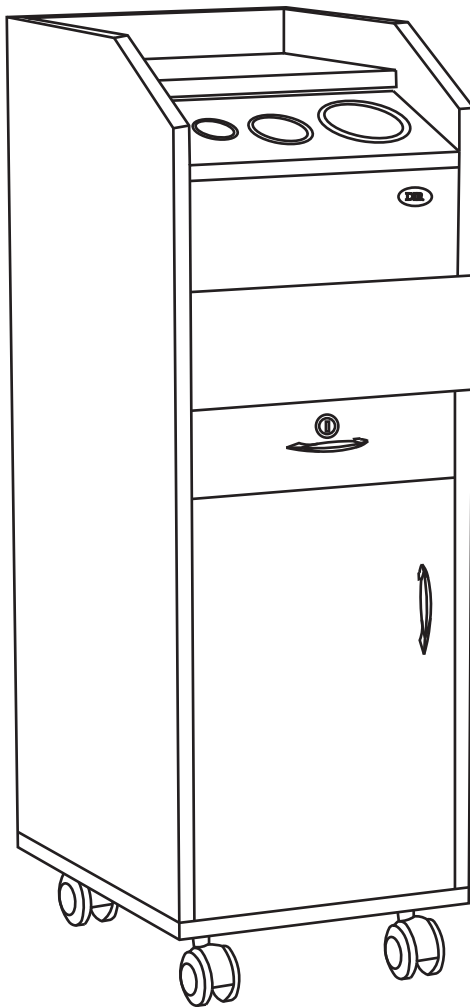

# Simplex

5107

INSTRUCTION MANUAL

# List of Parts & Tools

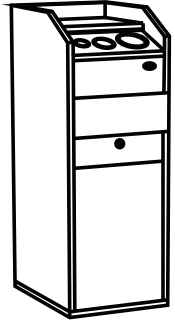

x1

101001

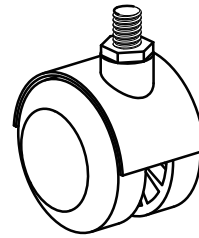

x4

101002



x3

101003

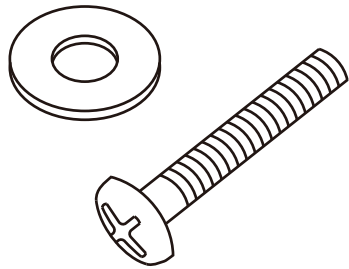

x6

101004

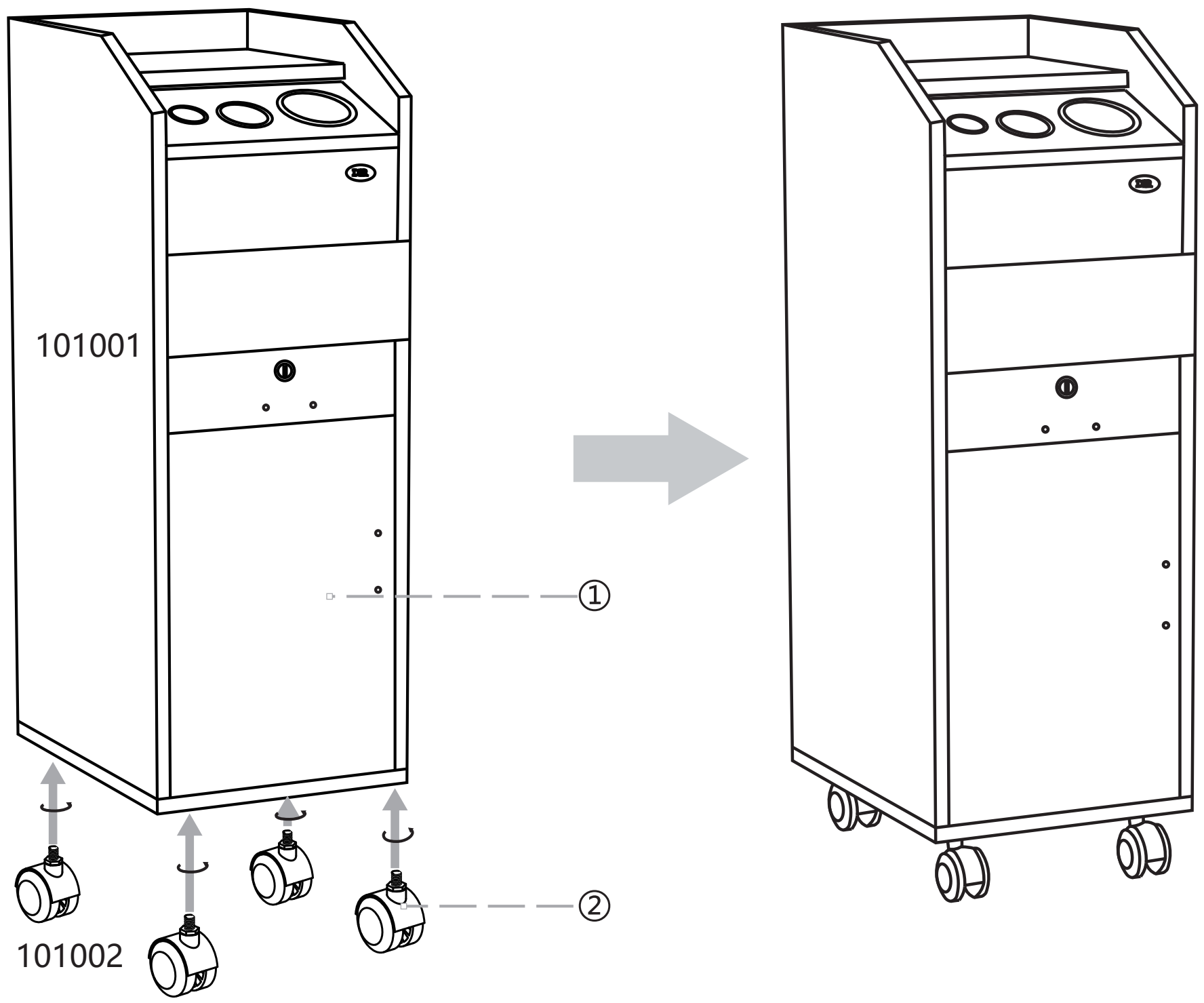

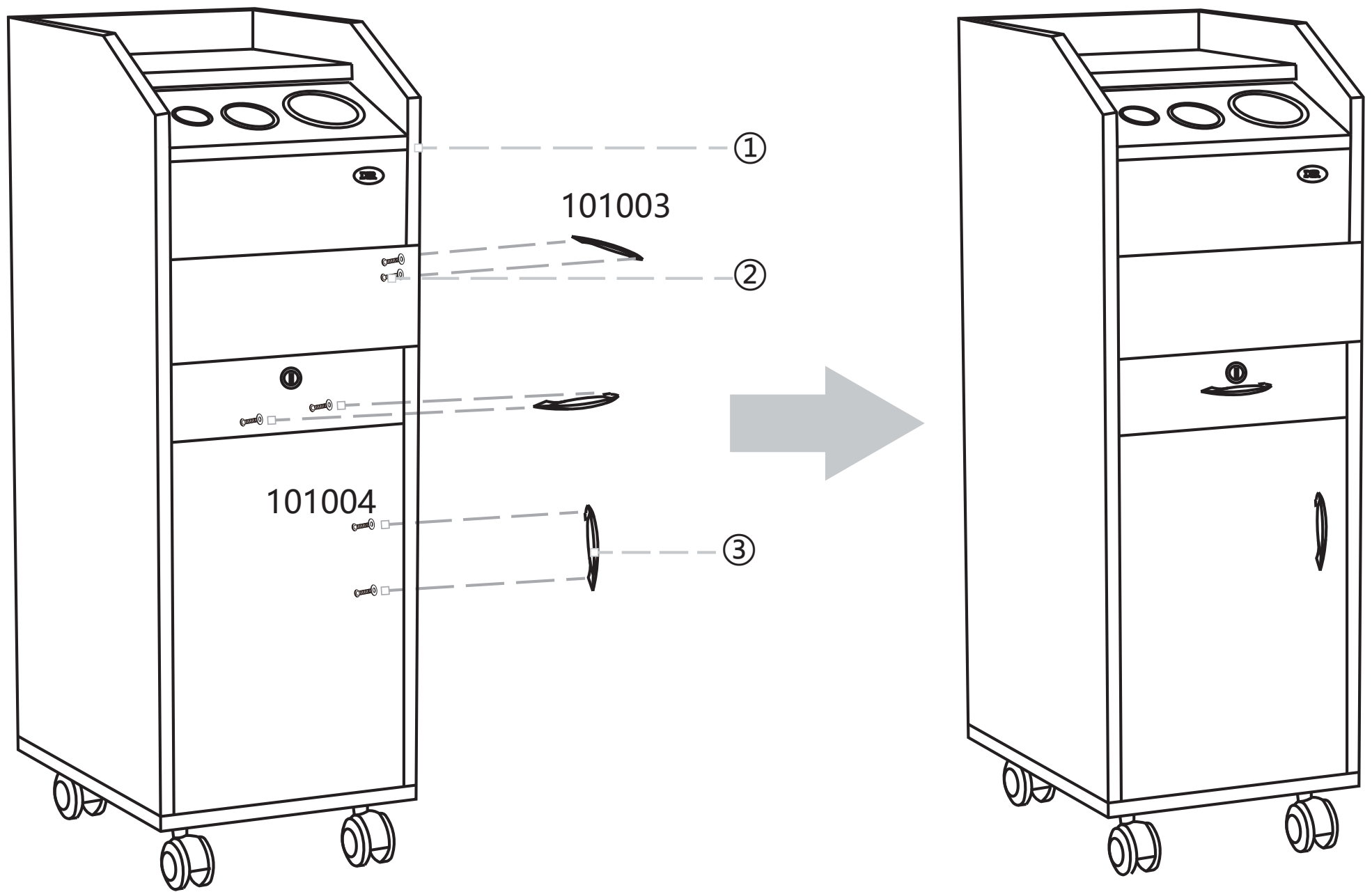

## Product care



Brush away excess hair

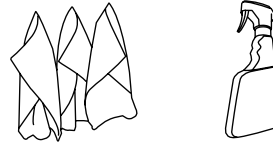

Clean surface with damp cloth or use simple soap & water solution.

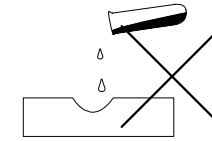

Avoid using corrosive cleaning agents such as bleaches.

## Warranty

The warranty period is one year. DIR warrants to you, the original buyer, that goods shall be free of defects in material and/or workmanship attributable to manufacture for one year from date of receipt of product. Damage resulting from improper handling after merchandise is received, or from exposure to weather or extreme atmospheric conditions is not covered by the warranty. For any other information please contact our support team:

### DIR BIRMINGHAM

66 Rea Street South  
Birmingham  
B5 6LB  
UK

Tel:  
+44(0)121 6434777

Email:  
dirsalon@gmail.com

### DIR LONDON

Unit 1 River Road  
Business Park  
33 River Road, Barking  
Greater London  
IG11 0DA  
UK

Tel:  
+44(0)20 8591 9310

Email:  
dirsalon@gmail.com

### DIR NEW YORK

575 Underhill Blvd.  
Suite 170  
Syosset, NY 11791  
USA

Tel:  
+1 (718)628-6668  
+1 (800)728-2008

Email:  
sales@dirsalonfurniture.com

### DIR IRELAND

Unit 20, Goldenbridge Ind.  
Estate Tyrconnell Road  
Inchicore  
Dublin 8  
Republic of Ireland

Phone:  
+353 (1) 429 7969

Email:  
sales.ireland@dirgroup.ie