

DIR[®]

Damita II Free Standing

P07FS/H177
INSTRUCTION MANUAL

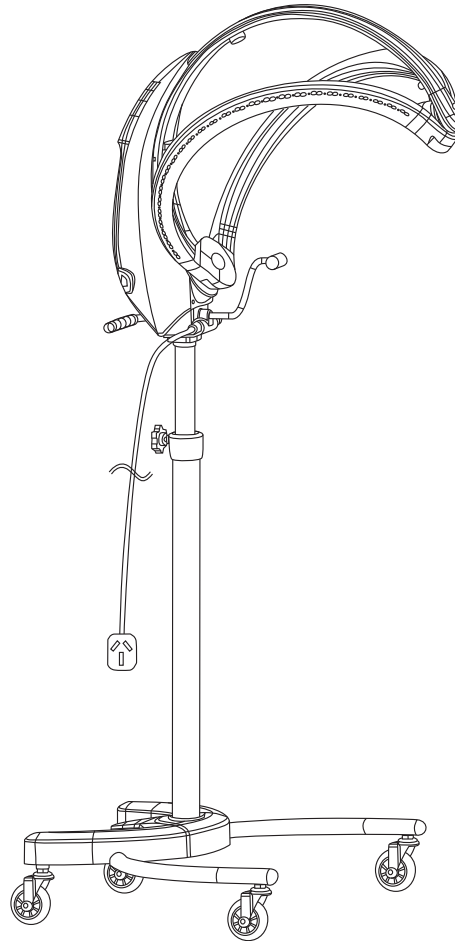

Assembly Instructions

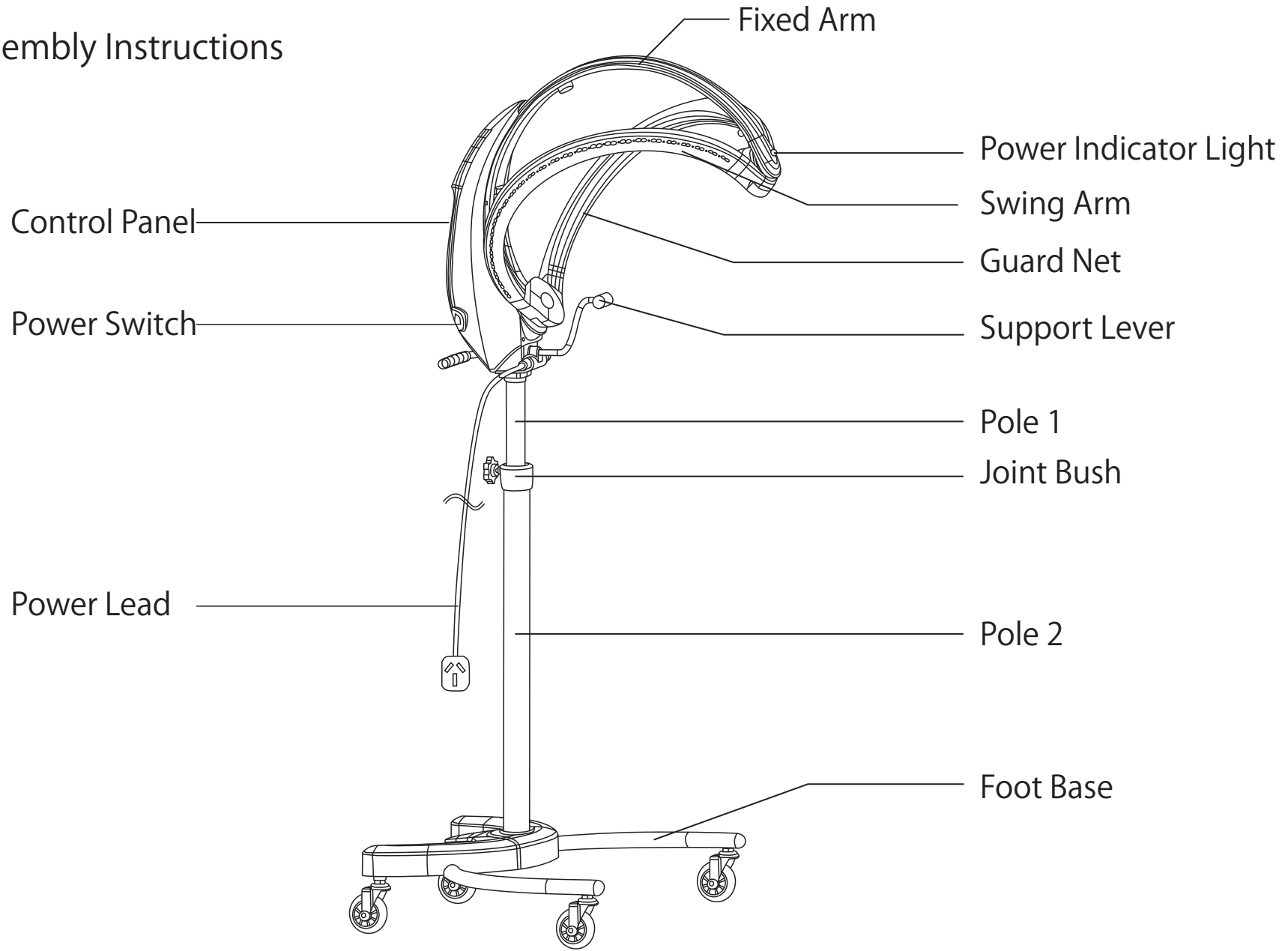

Assembly Instructions

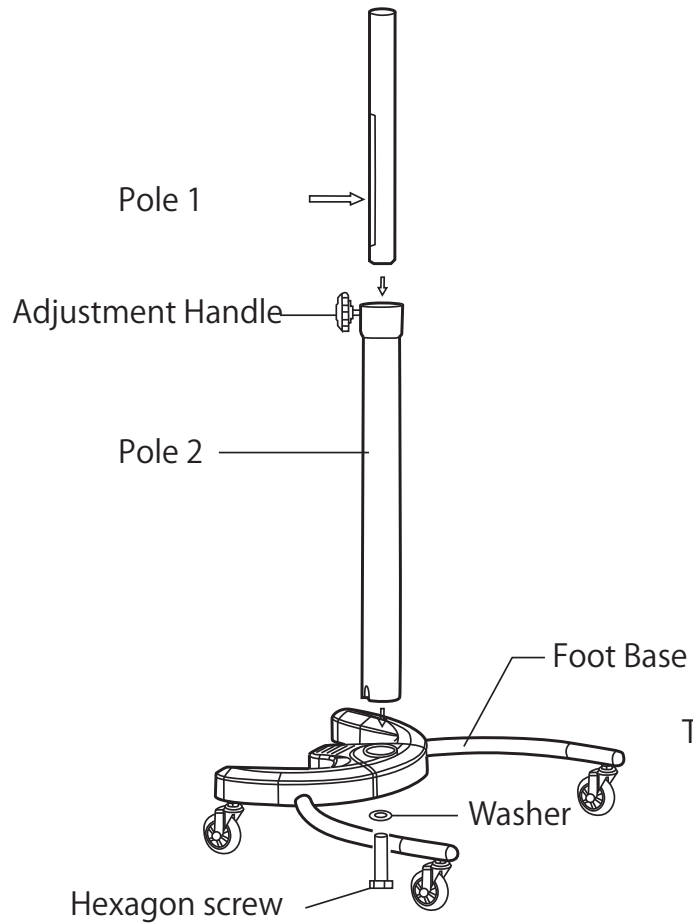

Note: Please ensure that the slot on the pole 1 faces the adjustment handle

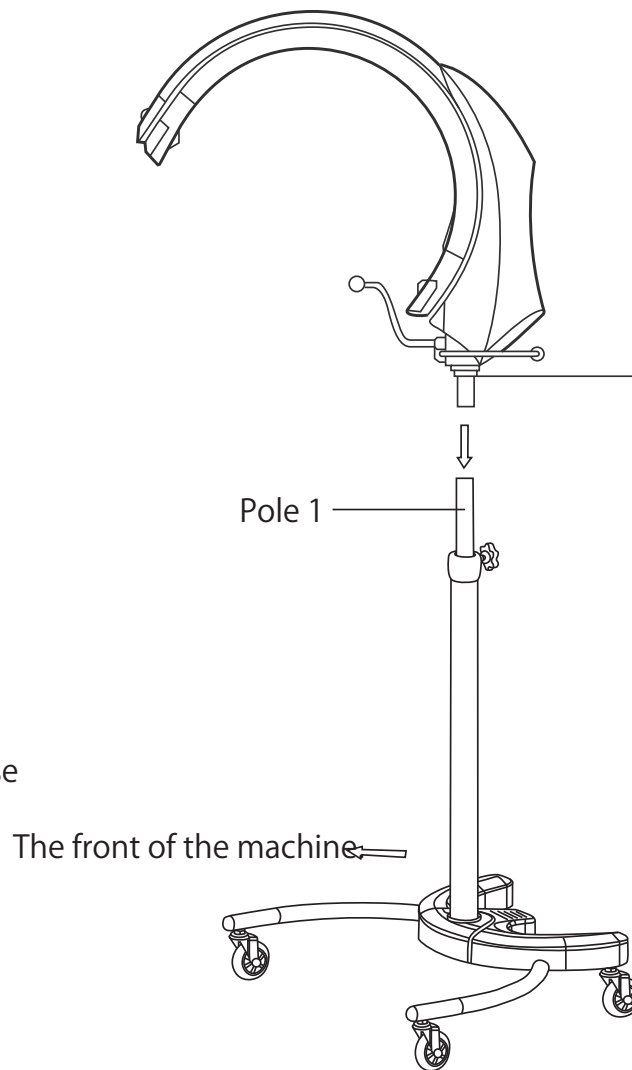

Note: Please ensure that the head assembly faces the front of the machine correctly.

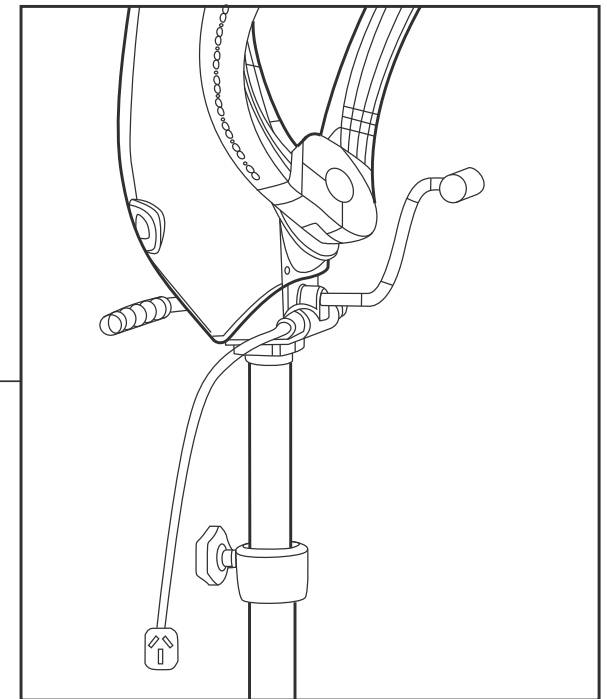

Fix the head assembly on the pole 1 and tighten it with the screw.

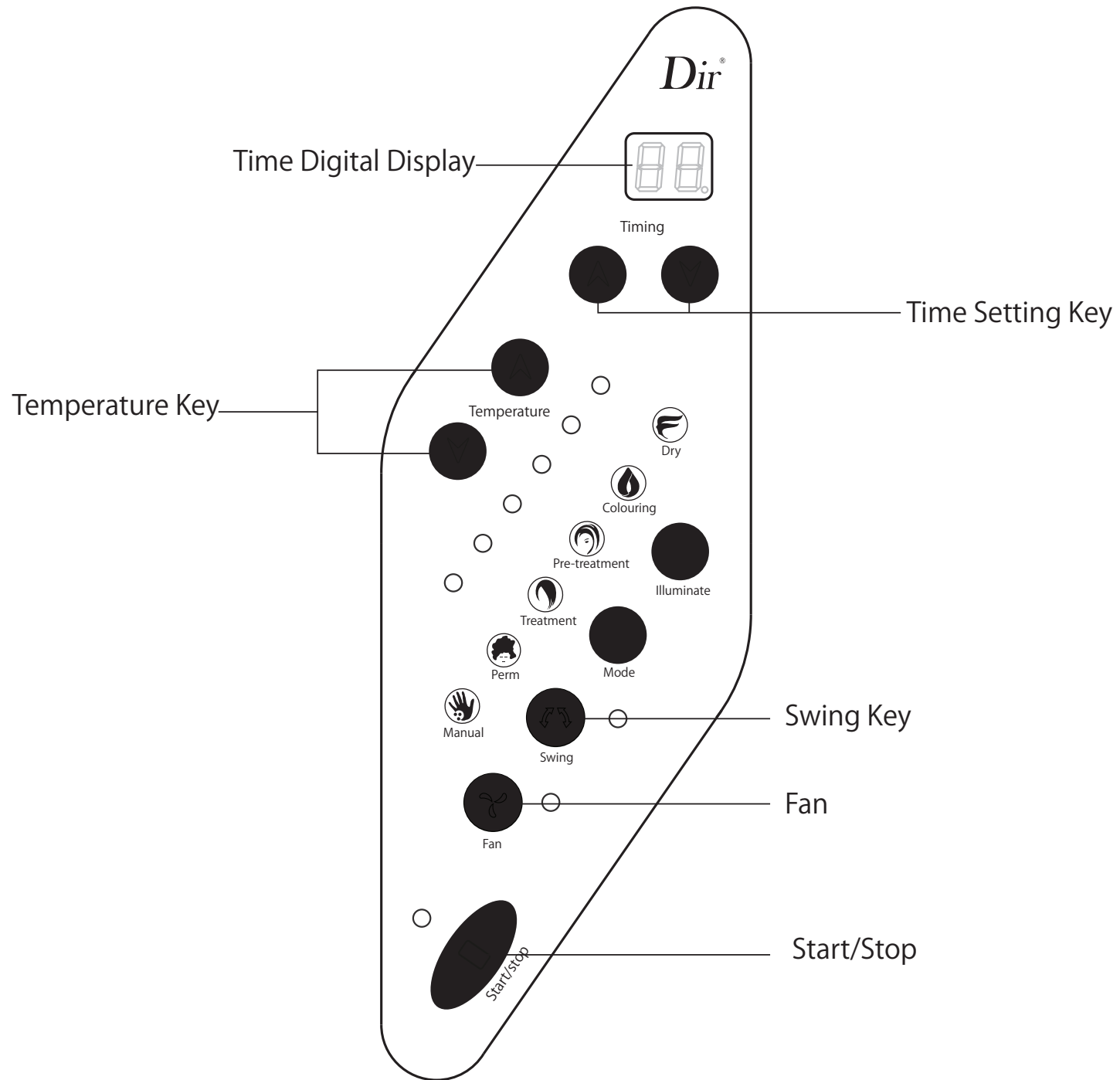

Control Panel

Start/Stop

Press this key to start or end treatments. When the machine is on the control panel will illuminate, when the machine/treatment stops the control panel will not illuminate.

Fan

Push this key to start/stop the fan. The control panel will illuminate if the fan is in operation, once the treatment has come to an end the control panel will not light.

Swing Key

Push this key to stop the arms swinging refraining from any movement, by pressing this key twice the arms will resume movement. The control panel will illuminate when the arms are in operation, when the arms are no longer in use the panel will not light.

Selecting Mode Key

By pressing this key this machine enables you to choose from one of the six built in modes, listed below...

A. Dry	B. Colouring	C. Pre-treatment	D. Treatment	E. Perm	F. Manual
--------	--------------	------------------	--------------	---------	-----------

The control panel will illuminate the mode selected.

Temperature Keys

Press \triangle to increase the temperature by 1 level.

Press ∇ to decrease the temperature by 1 level.

The temperature selected will illuminate on the control panel.

Time Setting Keys

Press \triangle to increase the time by 1 minute, hold the key to increase time up to 60minutes.

Press ∇ to decrease the temperature by 1 level, hold the key to decrease time down to 1 minute.

The temperature selected will illuminate on the control panel.

Digital Indicator

The indicator will show the time remaining on the current treatment. When the treatment has come to an end the indicator can be a LCD time display.

Technical Description

AC 110-120V	50/60Hz	750W
AC 220-240V	50/60Hz	750W

To get the best results out of this product and to ensure customers comfort, please follow the steps listed below...

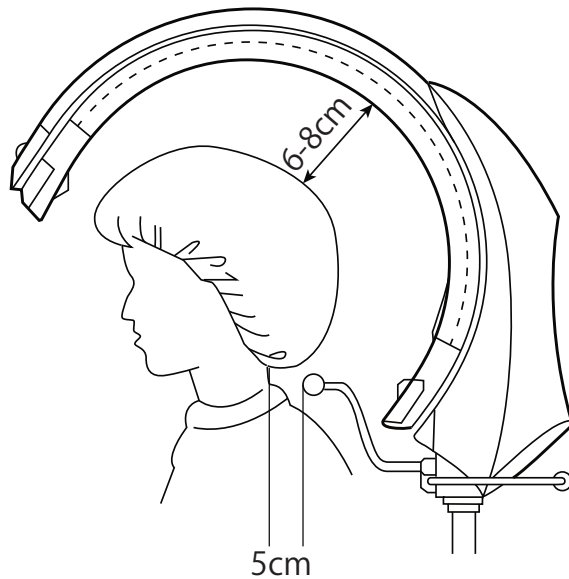

Diagram 1

Step 1

Damita should be adjusted and placed 6-8cm from the back of the customer's head and 5cm (2") from the rear of the customer's neck.

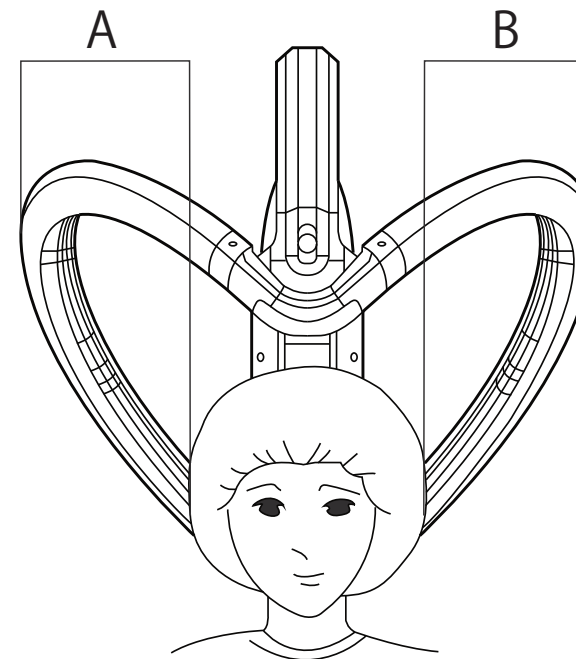

Diagram 2

Step 2

The distances between A and B should be exact. (As in diagram)

Operation Manual

Note: Please read the information regarding suitable positioning, before operating.

Turn on Machine

1. Turn on the power switch, the LED light will glow.
2. The control panels default is set to "Manual"

Select a Mode

1. Select "Choose Mode" and select the treatment required.
2. Temperature level, time and fan can be adjusted according to treatment.

Start/Stop

1. The machine will start to heat as per the selected working mode, during this time the LED control panel will glow.
2. The LED will continue to glow until the machine stops.
3. The arms will start movement and heating

During Operation

1. The start/stop, temperature and time indicators LED will continue to light during operation.
2. During the working mode you may alter the time and temperature by using the time/temp buttons.

Changing Current Mode

1. Push the "start/stop" key to interrupt the treatment. The arms and indicator light will enter standby mode.
2. The modes and temperature levels will shine after you have reselected a new programme.
3. Time light will be off and the indicator will show the preliminary set time.
4. Select the new mode you wish to switch to then select the "start/stop" key. The machine will now resume with the new selected mode.

Finish Treatment

1. The control panel will sound when the treatment has come to an end.
2. The arms will automatically move back to the default position and stop heating.
3. Start/Stop and Indicator light will turn off.
4. The modes and temperature levels will glow.
5. The digital time indicator will show as "0" when the machine has finished operation. The time light will then flash once per second to start counting down any extra time.

Turn Off Power Source

1. Turn off machine by the power switch.
2. Please pull out the power plug, if machine is not in use for a long period of time

Note During operation, the fan can be turned on/off at your will. The machine can resume to original position when the set time is up. The control panel will sound and the time will indicate as "00" and begin to re-calculate the time.

Cautions

1. Avoid use in extreme hot or cold temperatures.
2. Please use correct power source

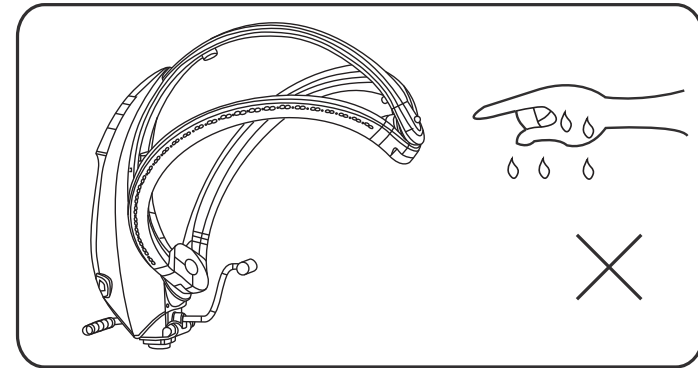
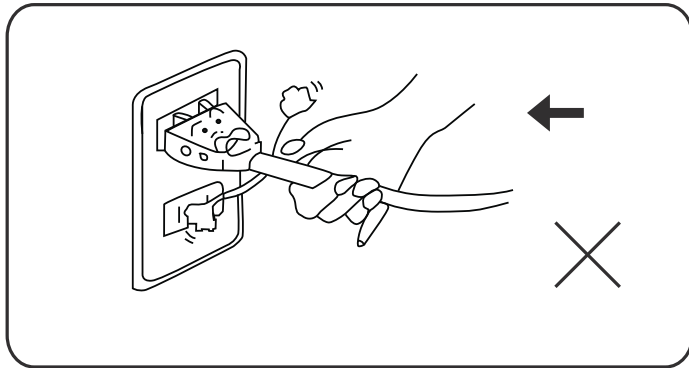

4. Dry hands before use.

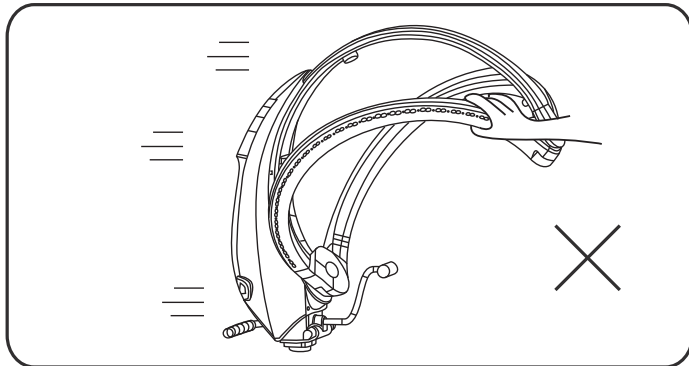

5. Do not touch during operation – Hot Surfaces.

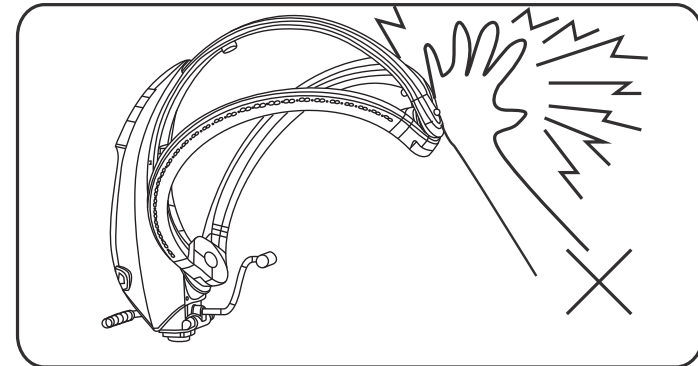

6. Do not move or lift product when in use. This could damage the machine as well as causing damage to customer/stylist.

Cautions

1. Before using please make sure that the service voltage is the same as the products appropriate rating.
2. Operating environment; an ambient temperature of 5'c -40'c; a relative humidity of less than 95%.
3. To ensure users safety, never insert foreign objects into the machine.
4. Be sure never to use flammable gas or use machine under similar environments.
5. After switching on the power; if you find any abnormal conditions, please contact the technical department immediately – do not attempt to repair yourself.
6. Don't remove the plug by pulling the cable. Please first hold the plug then pull.
7. This machine is strictly prohibited to use outdoors/outside.
8. If the cable is found to be damaged, in order to avoid danger, it should be replaced by the manufacturer.
9. Water must be purified. Don't add or use any cosmetic liquids, astringent, toning lotion, perfume, carbonated water or mineral water (un-pure tap water), otherwise that will induce the machines function and/or create a hyper susceptibility to customers skin.
10. Please keep children away from the machine when in use,
11. If you suffer from any medical condition, please consult your local GP before use.

Modes-Application & Reference Work State

Mode	Application	Pre-fixed Functions				
		Time	Fan	Rotation	Temp level	Initiative time of temp level
Perm	When perming, adjust time and temp level according to type of hair & treatment	10 min	Off	On	4	2.5 min
		Adjustable according to condition and method				
Colouring	When dying hair, adjust time and temp level according to type of hair & treatment	15 min	Off	On	4	2.5 min
		Adjustable according to condition and method				
Pre-treatment	Adjust time and temp level according to type of hair & treatmentttt	20 min	Off	On	5	3 min
		Adjustable according to condition and method				
Treatment	Used for perm, colouring & treatments with bleach	15 min	On	On	4	2.4 min
		Adjustable according to condition and method				
Dry	Used for drying hair & natural styling	18 min	On	On	6	3.5 min
		Adjustable according to condition and method				
Manual	Used for several modes. Works together according to technique or hairstylist	10 min	On	On	3	2 min
		Adjustable according to condition and method				

Notes: 1. Machine default is set to manual.

Maintenance

Before cleaning please remove the power cord

1. The inside of the machine helmet is easy to stain and get dirty, please clean this regularly. Chemicals such as hair dye etc can cause the machine to dysfunction.
2. Use a soft, dry cloth to wipe and clean. If water/liquids splash onto the control panel, use a soft dry cloth to remove immediately, otherwise this could also cause the machine to dysfunction.

█ Please do not use the following substances to clean: thinner, alcohol, gas, coal, oil or any other harmful chemicals

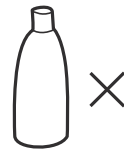
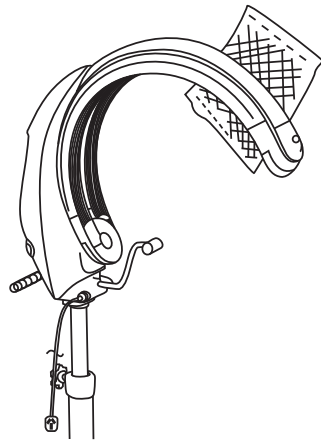

Thinner or Benzene



Neutral detergent

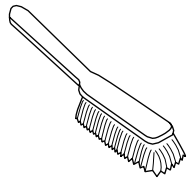

Brush away excess hair

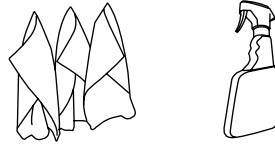

Clean surface with damp cloth or use simple soap & water solution.

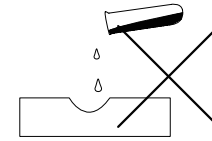

Avoid using corrosive cleaning agents such as bleaches.

Warranty

The warranty period is one year. DIR warrants to you, the original buyer, that goods shall be free of defects in material and/or workmanship attributable to manufacture for one year from date of receipt of product. Damage resulting from improper handling after merchandise is received, or from exposure to weather or extreme atmospheric conditions is not covered by the warranty. For any other information please contact our support team:

DIR BIRMINGHAM

66 Rea Street South
Birmingham
B5 6LB
UK

Tel:
+44(0)121 6434777

Email:
dirsalon@gmail.com

DIR LONDON

Unit 1 River Road
Business Park
33 River Road, Barking
Greater London
IG11 0DA
UK

Tel:
+44(0)20 8591 9310

Email:
dirsalon@gmail.com

DIR NEW YORK

575 Underhill Blvd.
Suite 170
Syosset, NY 11791
USA

Tel:
+1 (718)628-6668
+1 (800)728-2008

Email:
sales@dirsalonfurniture.com

DIR IRELAND

Unit 20, Goldenbridge Ind.
Estate Tyrconnell Road
Inchicore
Dublin 8
Republic of Ireland

Phone:
+353 (1) 429 7969

Email:
sales.ireland@dirgroup.ie