

DIR[®]

Tranquility

8818

INSTRUCTION MANUAL

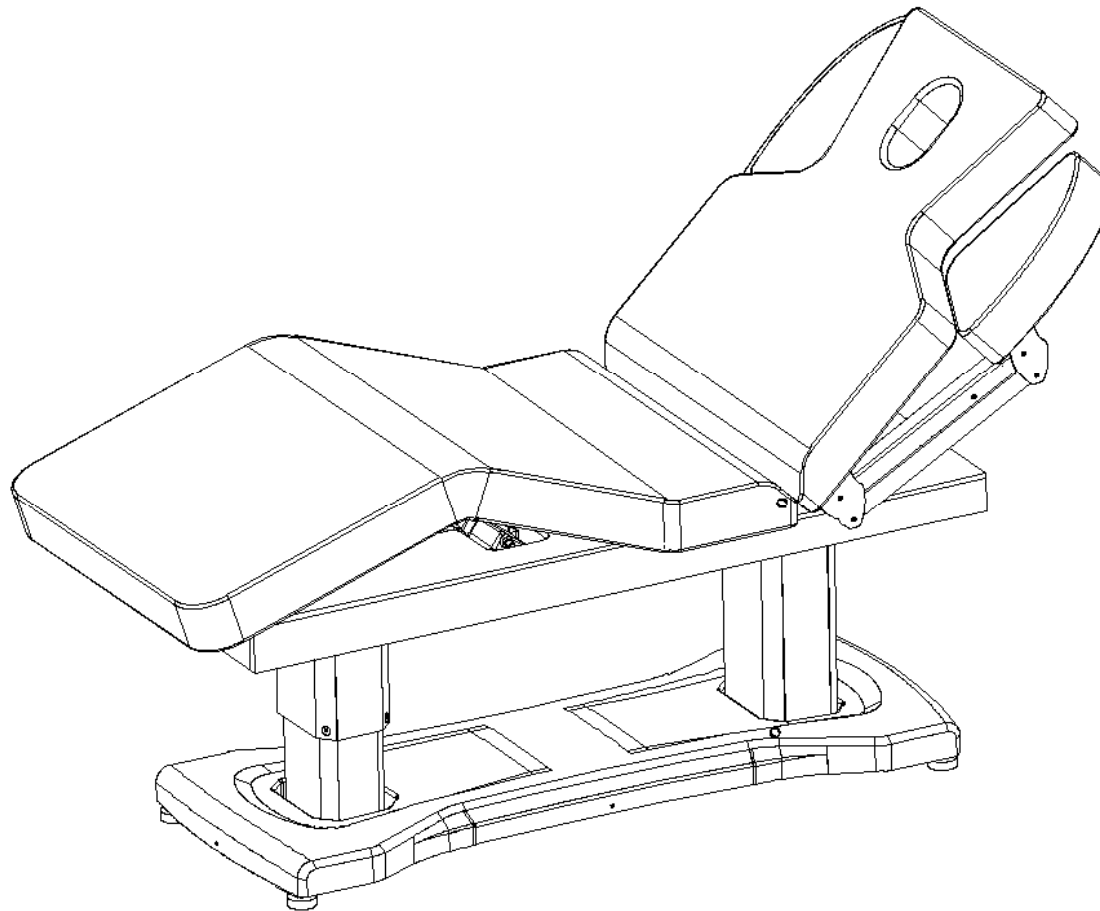

Technical data

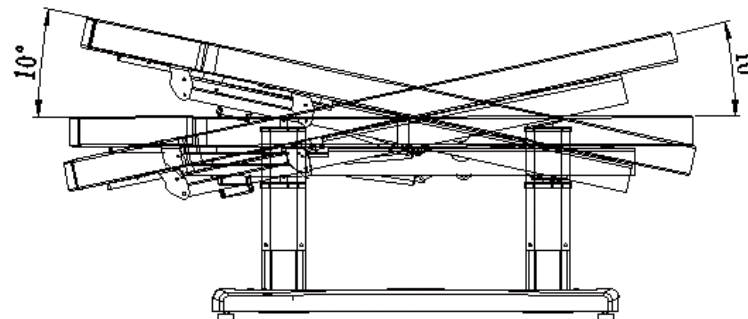
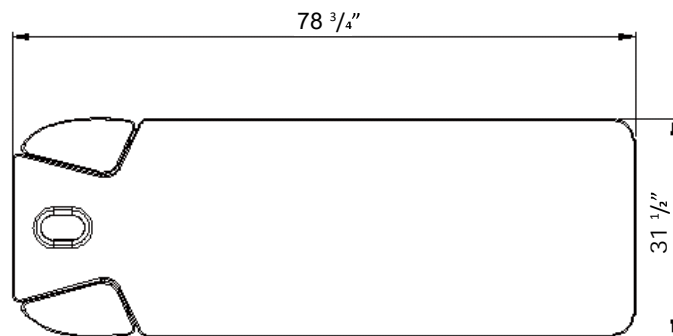
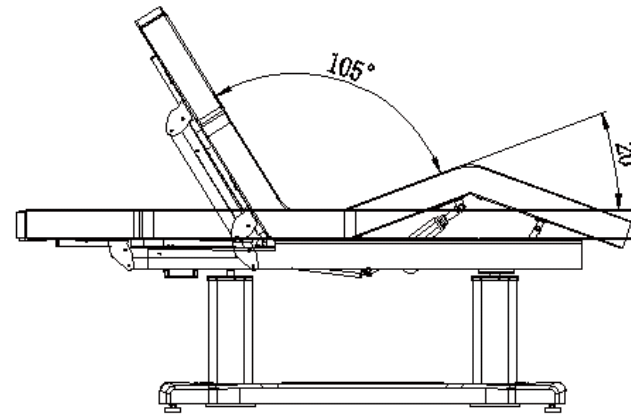
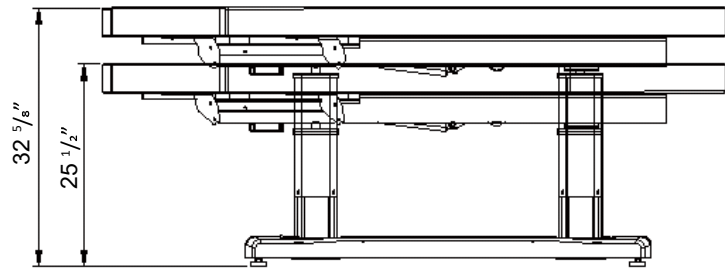

	UK	USA
Size	200*80*65-83cm	78 3/4"*31 1/2"*25 1/2"-32 5/8"
Load	200kg	440lb
Net weight	103kg	227lb
Adjust height range	65~83cm	25 1/2"~32 5/8"
Padding	10cm sponge	4" sponge

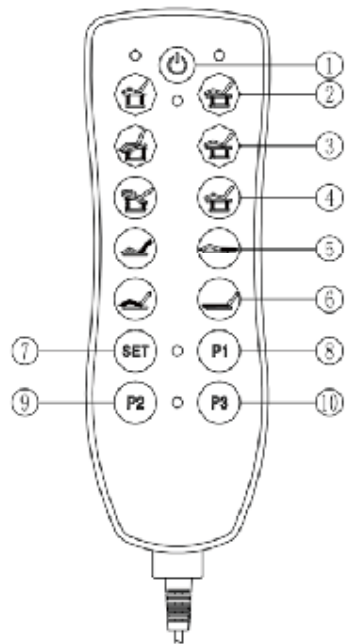

Remote controller:



① SW1

Press  turn on the remote;press  again ,turn off the remote ,the bed would be back to original position. Then press one more time during the process,the bed would be stopped

② SW2

Press  whole bed raise up,press  whole bed go down

③ SW3

Press  or  control the bed the Incline upward

④ SW4

Press  or  control the bed the Incline Downward

⑤ SW5

Press  or  control the backrest up and down.

⑥ SW6

Press  or  control the footrest up and down

⑦ SW7

A long press  to start the memory function

⑧ SW8

press **P1** Memory state 1

⑨ SW9



press **P2** Memory state2

⑩ SW10

press **P3** Memory state 3



●Usage method :

Backrest height adjustment :

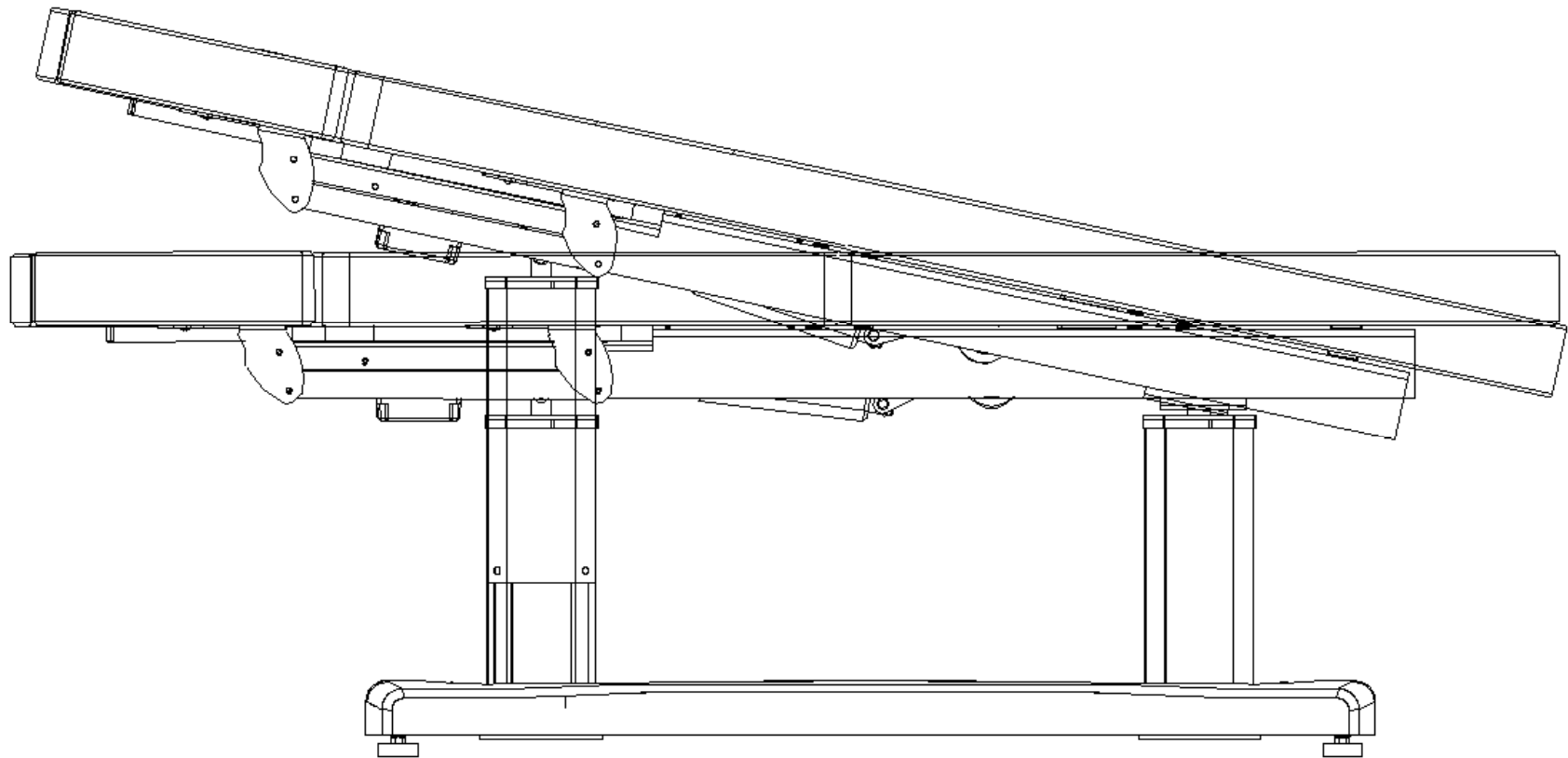
press  or  to adjust the angle of recline up for the whole bed. (Backrest section rise but footrest section keep stationary) or come to plat status. As below picture:



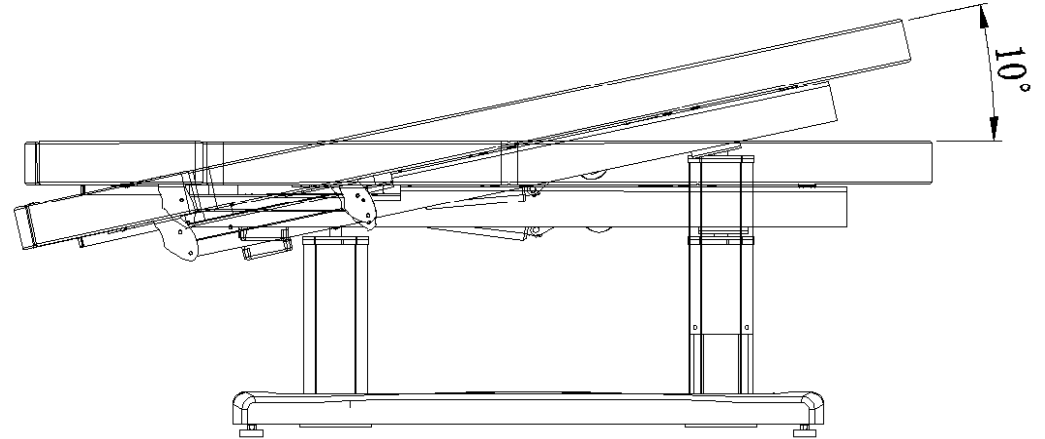

Footrest height adjustment :

press  or  to adjust the angle of recline down for the whole bed. (Backrest section keep stationary but footrest section rise up) or come to flat status. As below picture:



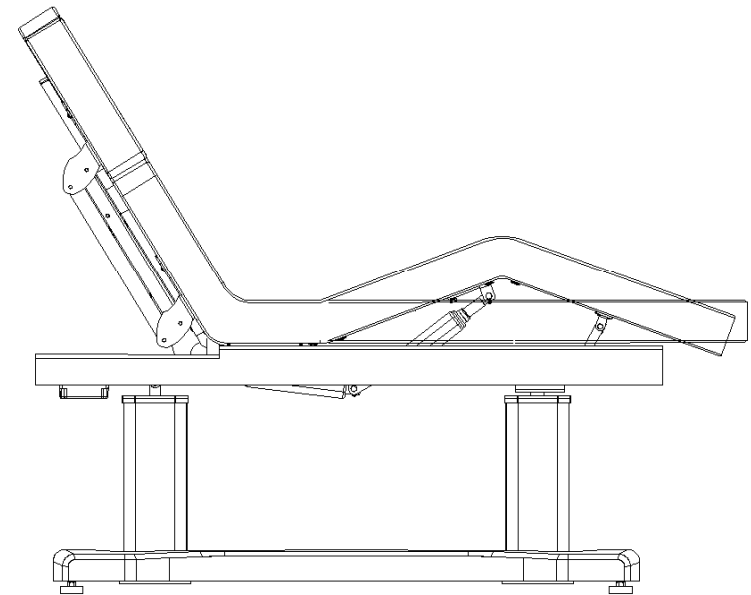

Backrest adjustment :

Press  or  to control backrest recline angle. As below picture:



Footrest adjustment :

Press  or  to control footrest recline angle. As below picture:

Handrest adjustment :

See below picture: as per arrow direction, keep pressing the gas piston and meanwhile press the handrest to the angle you want. Or it will recover by opposite method.

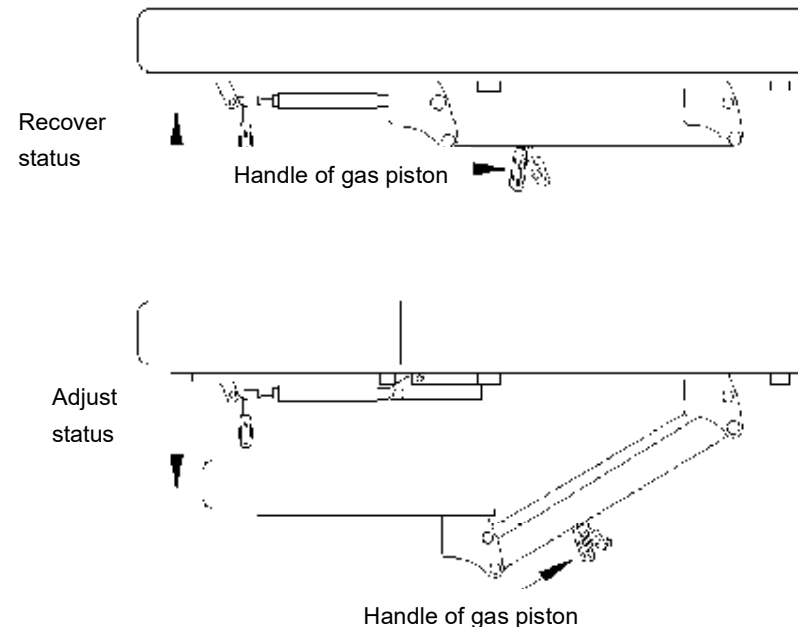

The suggestive instructions:

1. This electric massage bed uses a three-wire power cable. Meanwhile it should be inserted into the three-hole outlet where there is a ground electrode. And it should be assured that it can be connected to the ground electrode smoothly so that it can prevent people from getting electric shock while functioning normally.
2. All the plugs, buttons and other components connected to the power cable must not dip in the water or other liquid.
3. It is forbidden to put your hands, feet, head or other part of the body into the gap while massage chair is running when you press the manual control panel or the foot control panel.
4. It is prohibited to use when plugs, buttons and other components connected to the power cable are broken.
5. It should be noticed that the frequency is 6min/h when the motor of this massage chair is used.
6. The maintenances should not be dealt with without official training.

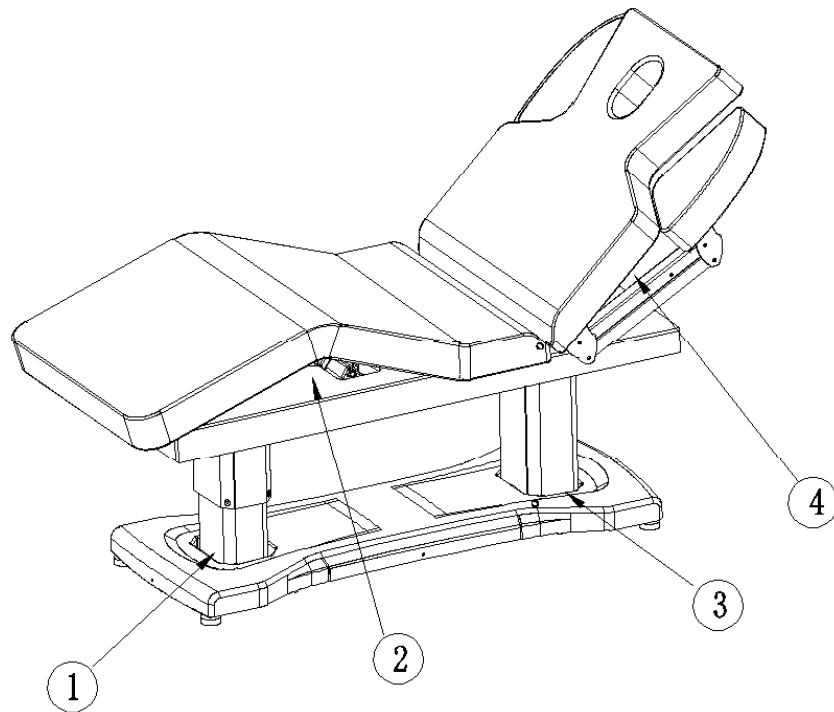

Attentions

1. Someone with osteoporosis or heart problem should not use this massage chair.
2. Women being pregnant or in menstruation should not use this massage chair.
3. Someone inured or with disabilities should not use this massage chair.
4. Children under 14 years old without any supervision and someone unconscious should not use this massage chair.
5. Breakages of the power cable and plug should be eliminated before it' s normally used. Breakages should be dealt with by someone professionals or service providers.
6. The voltage should accord with the safety voltage before it' s officially used. And the wrong voltage may lead to the breakdown of the product.
7. Wet hand is not allowed to touch power to avoid shock.
8. The product should not plug in before it' s already installed.
9. The power cable should be put away so that pedestrian will not trip up and fall.
10. The appearance of the product should cleaned by the use of the soft towel with diluted neutral detergent.
11. It should be unplug when it' s not used.
12. Do not dismount this product without any authorization. Please inform the official service providers to deal with the maintenances

Maintenances

1. Daily cleaning

You can wipe out the dust by using soft dry towel.

2. Eliminating the heavy dirt

As we all know, it is hard to eliminate the heavy dirt by using normal dry towel. In this case, you can use soft towel with diluted neutral detergent to clean it first. And then you can use dry towel to scrub.

3. It's prohibited to use benzene, diluent, gasoline or other solvent

These solvents may damage the leather or it may cause the corrosion of the products' appearance.

4. Storage and operating environment

Don't put the product under the strong sunlight and moisture environment. Otherwise it may cause the damages of the product.

5. It is allowed to use this product under the temperature from -5°C to 50°C and the humidity from 45% to 85%.

Fault Diagnosis

If there is something wrong when you use the product, please try to check and eliminate the wrong operation as followings.

Phenomenon	Diagnosis	Operation of elimination
Press the button on the remote but without any responses.	1. The function of control button has reached to maximum. 2. To check if the power plug is connected. 3. To check if each connecting plug of the transformer is connected.	1. Try to press other control button. 2. Disconnect the power plug and connect it again. 3. Disclose the chassis. Discharge the plug and connect it again.
Letting out noises and shaking while going up and down	Screw loosen	Tighten all the screws
The light is still off although the switch is on.	The fuse has burned out.	Replace the fuse.

Remarks: It will be not informed if the improvements of the product do not influence appearance and function.

Product care



Brush away excess hair



Clean surface with damp cloth or use simple soap & water solution.

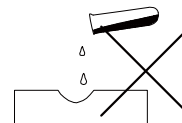

Avoid using corrosive cleaning agents such as bleaches.

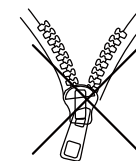

Do not remove upholstery for cleaning

Warranty

The warranty period is one year. DIR warrants to you, the original buyer, that goods shall be free of defects in material and/or workmanship attributable to manufacture for one year from date of receipt of product. Damage resulting from improper handling after merchandise is received, or from exposure to weather or extreme atmospheric conditions is not covered by the warranty.

For any other information please contact our support team:

DIR BIRMINGHAM

66 Rea Street South
Birmingham
B5 6LB
UK

Tel:
+44(0)121 6434777

Email:
dirstalon@gmail.com

DIR LONDON

Unit 1 River Road
Business Park
33 River Road, Barking
Greater London
IG11 0DA
UK

Tel:
+44(0)20 8591 9310

Email:
dirstalon@gmail.com

DIR NEW YORK

575 Underhill Blvd.
Suite 170
Syosset, NY 11791
USA

Tel:
+1 (718)628-6668
+1 (800)728-2008

Email:
sales@dirstalonfurniture.com

DIR IRELAND

Unit 20, Goldenbridge Ind.
Estate Tyrconnell Road
Inchicore
Dublin 8
Republic of Ireland

Phone:
+353 (1) 429 7969

Email:
sales.ireland@dirgroup.ie